

Mountain Garland

1

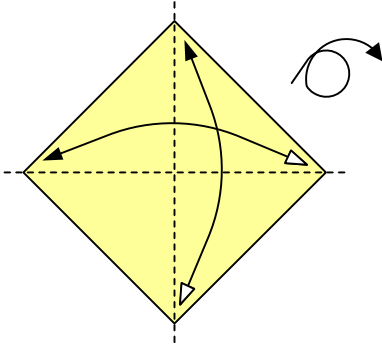

2

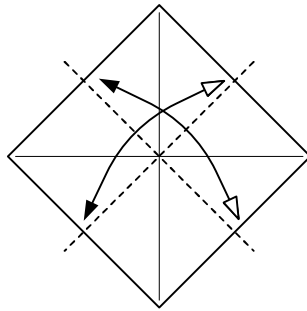

3

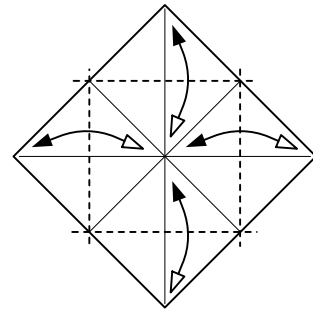

4

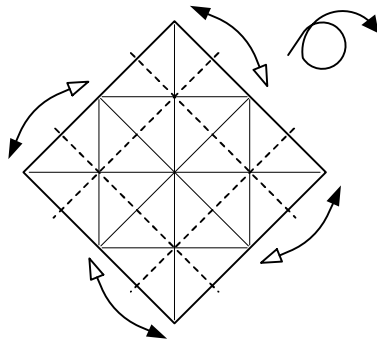

5

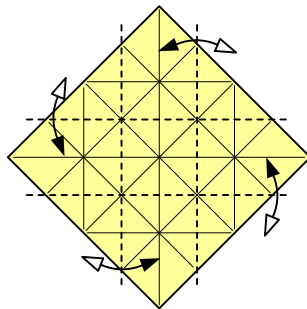

6

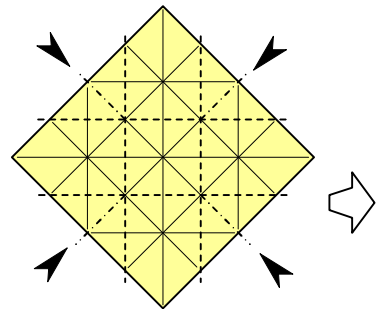

Form a box shape

7

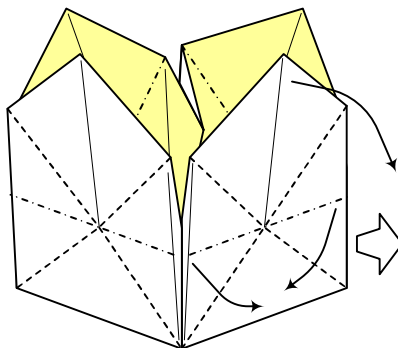

Make a "waterbomb" collapse on all 4 sides

8

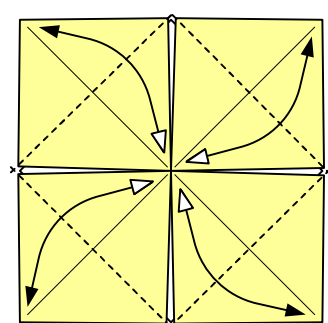

9

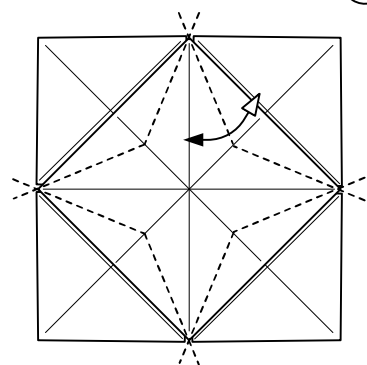

Pre-crease a bird base

10

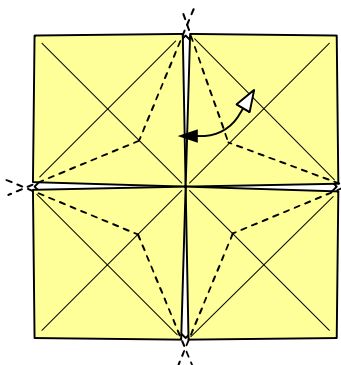

Pre-crease a single layer

11

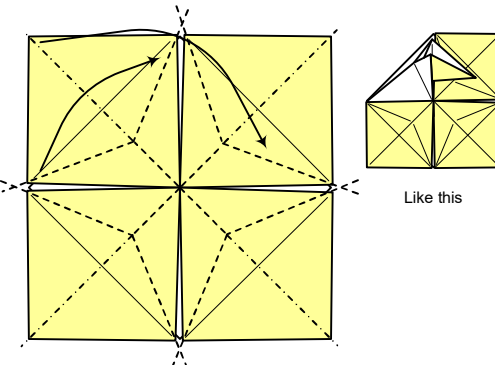

Like this

Reverse fold on the creases from step 10 while folding each square in half diagonally

12

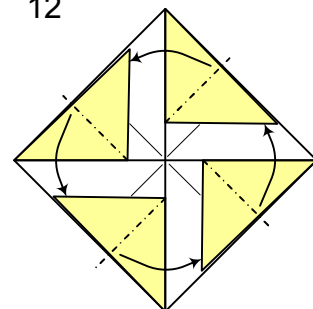

Squash folds

Mountain Garland

13

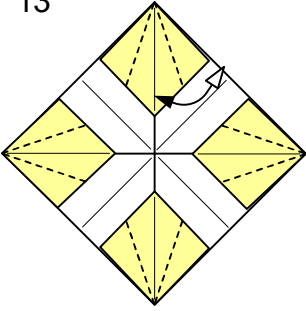

14

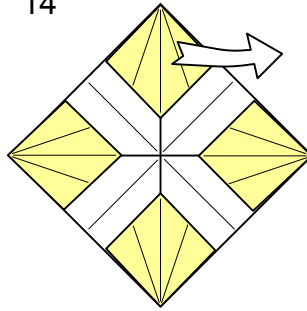

Unfold back to step 12

15

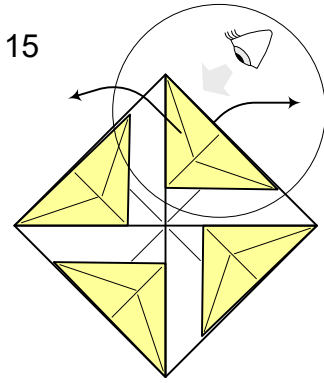

Open out slightly and view from between the layers

16

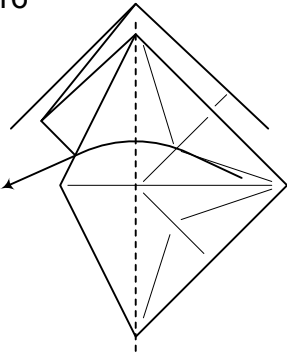

17

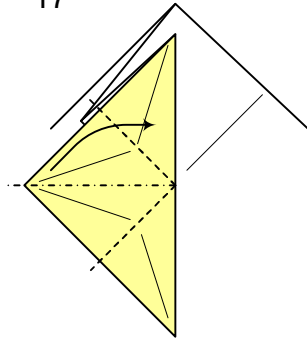

Reverse fold but do not flatten

18

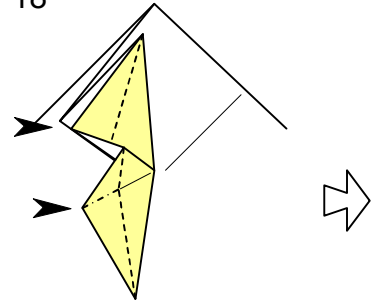

Two reverse folds, then flatten

19

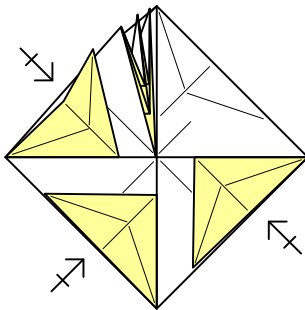

Repeat on the other 3 flaps

20

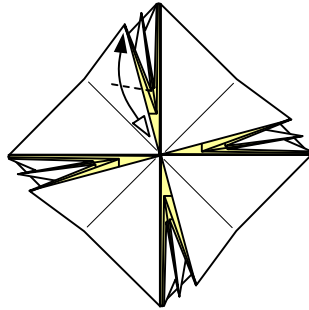

Crease the small points down as far as they will go, do not fold all the way to the edge

21

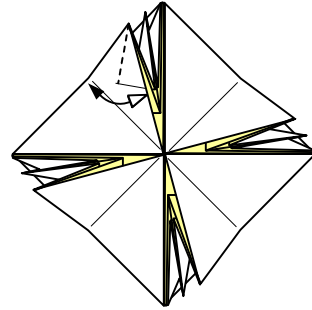

22

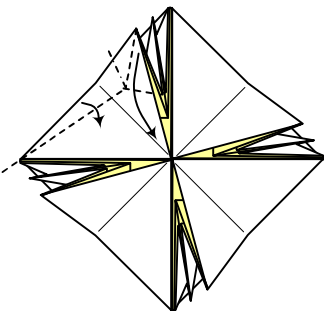

Rabbit ear

23

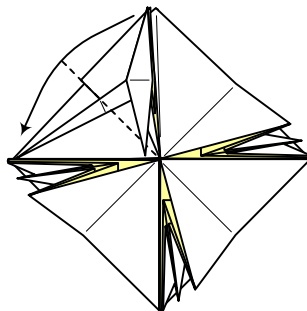

Swing the point to reveal the opposite side, there is no need to completely flatten the model

24

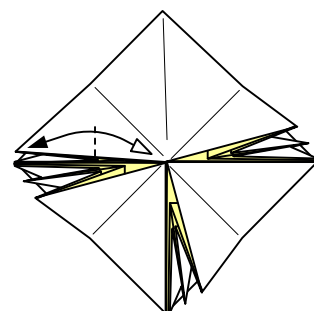

Repeat steps 20-23 on the other side

Mountain Garland

25

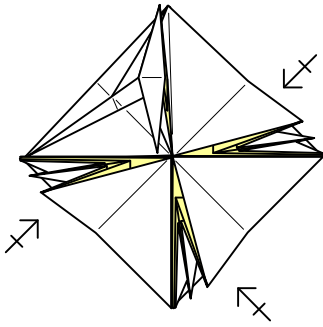

Repeat steps 20-24
on the other 3 points

26

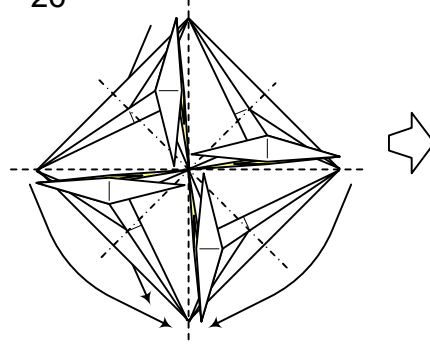

Preliminary fold, swing the flaps
with the small points to the side

27

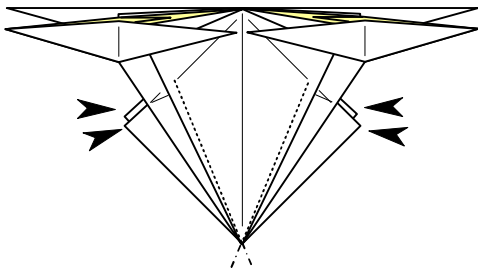

Inside reverse folds using the
creases made in step 9

28

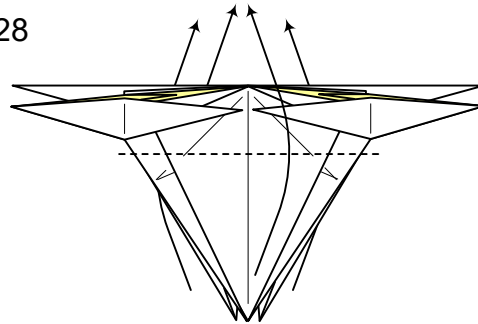

Fold all 4 points up as far as they will go,
do not trap the small points

29

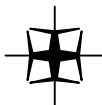
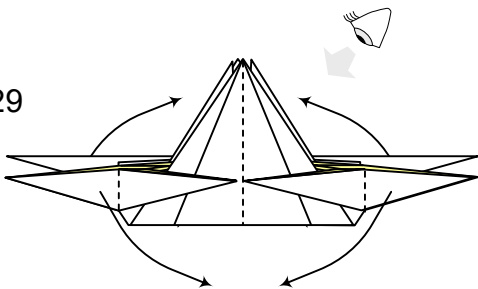

Spread the points so it
looks like this from the top

30

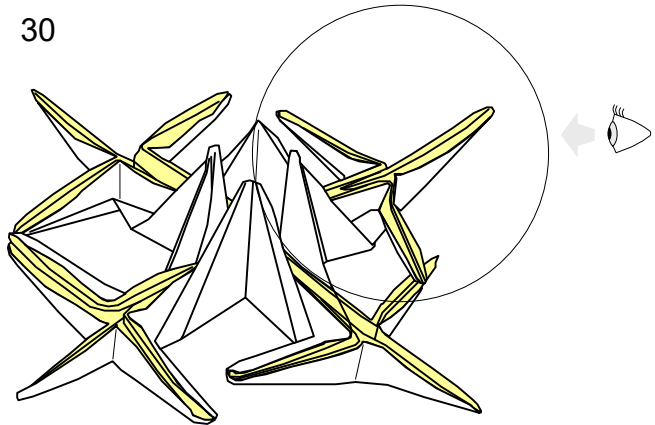

31

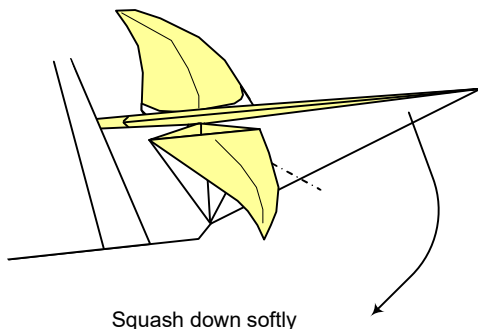

Squash down softly

32

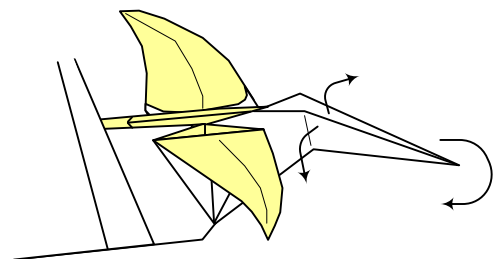

Separate the layers then curl the tip

Mountain Garland

33

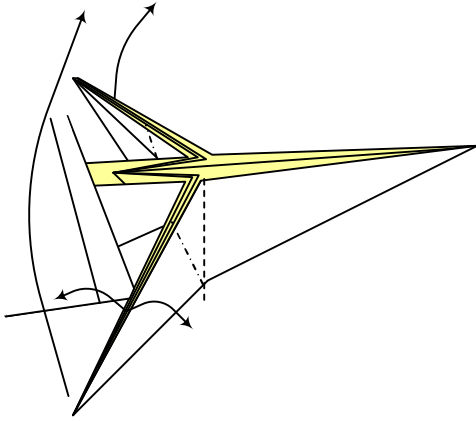

Squash fold symmetrically without making any firm creases

34

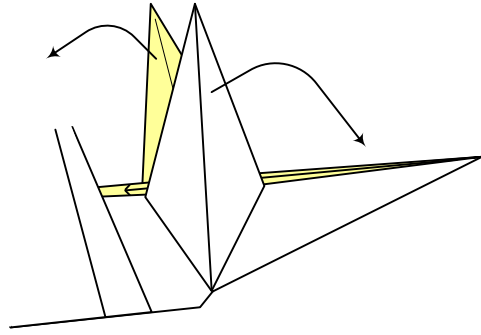

Curve the petals down

35

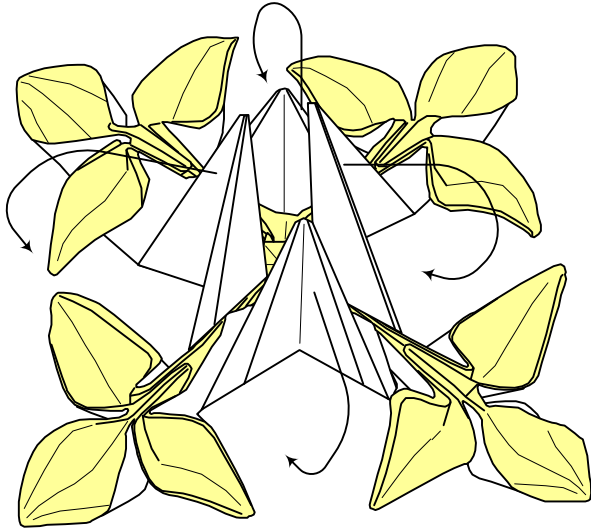

Curl the central points

